

GR-1200XL

(Left-hand drive)

120 Ton (110 Metric Ton) Capacity

SPEC. SHEET NO. GR-1200-3-00101/US-01

HYDRAULIC ROUGH TERRAIN CRANE

DIMENSIONS

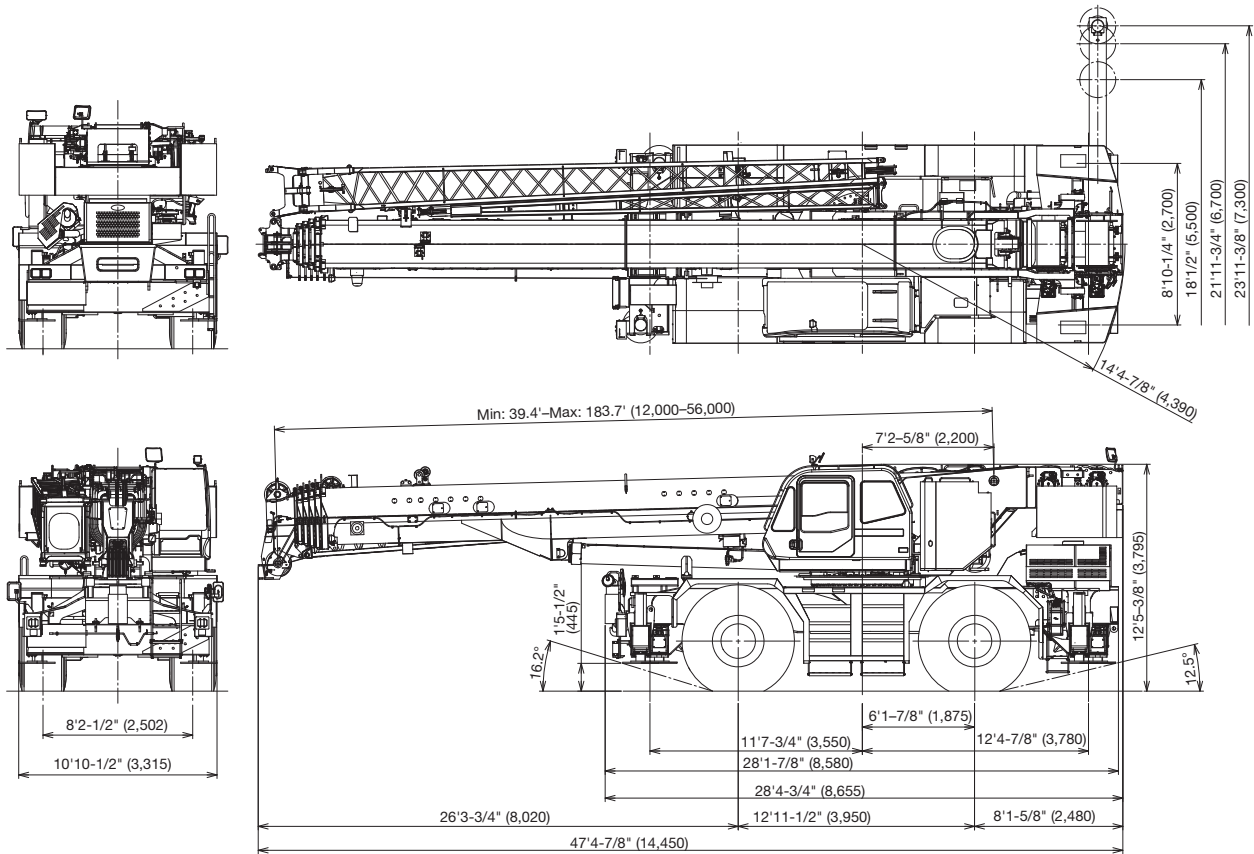

Note: Dimension is with boom angle at -1.5 degree.
() Reference dimensions in mm.

GENERAL DIMENSIONS

	Feet	Meter
Turning radius (29.5~25 34PR (OR))		
4 wheel steer	22' 4"	6.8
2 wheel steer	39'11"	11.9

	Feet	Meter
Overall length	approx. 47' 4-7/8"	14,450
Overall width	approx. 10'10-1/2"	3,315
Overall height	approx. 12' 5"-3/8"	3,795
Carrier length for traveling	approx. 28' 1-7/8"	8,580

CRANE SPECIFICATIONS

BOOM

6 sections boom of round box construction with 5 sheaves at boom head, extended by single telescoping cylinder.
2 easily removable wire rope guards, rope dead end provided on both sides of boom head. Boom telescope sections are supported by wear pads both vertically and horizontally.

Fully retracted length.....	39.4' (12.0 m)
Fully extended length.....	183.7' (56.0 m)
Extension speed.....	157.3' in 340 s
Sheave root diameter.....	15-3/4" (0.400 m)

BOOM ELEVATION

By a double acting hydraulic cylinder with holding valve.
Boom angle indicator.

Automatic speed reduction and slow stop function.

Boom angle	-1.5–81°
Boom raising speed	20° to 60° in 40 s

JIB

2 stage bi-fold lattice type, 3.5°, 25° or 45° offset.
Single sheave at the head of both jib sections. Stowed alongside base boom section. Assistant cylinders for mounting and stowing, controlled at right side of superstructure.
Self stowing jib mounting pins.

Length	33.2', 58.1' (10.1 m, 17.7 m)
Offset.....	3.5°, 25°, 45°
Sheave root diameter.....	15-5/8" (0.396 m)

AUXILIARY LIFTING SHEAVE (SINGLE TOP)

Single sheave, mounted to main boom head for single line work (stowable).

Root diameter.....	17-5/16" (0.440 m)
--------------------	--------------------

ANTI-TWO BLOCK DEVICE

Pendant type over-winding cut out device with audio-visual (FAILURE lamp/BUZZER) warning system.

SLEWING

Hydraulic axial piston motor driven through planetary slewing speed reducer. Continuous 360° full circle slewing on ball bearing turn table at 1.5 min⁻¹{rpm}. Equipped with manually locked/released slewing brake. A 360° positive swing lock manually engaged in cab. Twin slewing system: Free slewing or lock slewing controlled by selector switch on front console.
Slewing speed..... 1.5 min⁻¹ {rpm}

COUNTERWEIGHT

Standard weight..... 22,000 lbs (10,000 kg)

WINCH

MAIN WINCH

Variable speed type with grooved drum driven by hydraulic axial piston motor through speed reducer. Power load lowering and raising. Equipped with automatic brake (neutral brake) and counterbalance valve. Controlled independently of auxiliary winch. Equipped with cable follower and drum rotation indicator.

MAIN DRUM

Root diameter x wide	15" (0.382 m) x 29-1/4" (0.742 m)
Wire rope diameter x length	3/4" (19 mm) x 771' (235 m)
Drum capacity	1293' (394 m), 7 layers
Maximum single line pull (1st layer).....	21,800 lbs (9,900 kg)
Maximum permissible linepull wire strength...	15,900 lbs (7,200 kg)

AUXILIARY WINCH

Variable speed type with grooved drum driven by hydraulic axial piston motor through speed reducer.
Power load lowering and raising. Equipped with automatic brake (neutral brake) and counterbalance valve. Controlled independently of main winch. Equipped with cable follower and drum rotation indicator.

AUXILIARY DRUM

Root diameter x wide	15" (0.382 m) x 29-1/4" (0.742 m)
Wire rope diameter x length	3/4" (19 mm) x 518' (158 m)
Drum capacity	1293' (394 m), 7 layers
Maximum single line pull (1st layer).....	21,800 lbs (9,900 kg)
Maximum permissible linepull wire strength...	15,900 lbs (7,200 kg)

WIRE ROPE

Non-rotating 3/4" (19 mm) 7x35 class.
Breaking Strength 79,400 lbs (36,000 kg)

HOOK BLOCKS

120 ton (110 metric ton, option).. 7 sheaves with hook block and safety latch.

77 ton (70 metric ton, option)..... 5 sheaves with hook block and safety latch.

50 ton (45 metric ton, option).... 3 sheaves with hook block and safety latch.

7.9 ton (7.2 metric ton) Weighted hook with swivel and safety latch.

HYDRAULIC SYSTEM

PUMPS

2 variable piston pumps for crane functions.
Tandem gear pump for steering, swing and optional equipment.
Powered by carrier engine. Pump disconnect for crane is engaged/ disengaged by rotary switch from operator's cab.

CONTROL VALVES

Multiple valves actuated by pilot pressure with integral pressure relief valves.

RESERVOIR

202 gallon (763 lit.) capacity. External sight level gauge.

FILTRATION

BETA10=10 return filter, full flow with bypass protection, located inside of hydraulic reservoir. Accessible for easy replacement.

OIL COOLER

Air cooled fan type.

CAB AND CONTROLS

Both crane and drive operations can be performed from one cab mounted on rotating superstructure.

15° tilt, Left side, 1 man type, steel construction with sliding door access and safety glass windows opening at side. Door window is powered control. Windshield glass window and roof glass window are shatter-resistant. Tilt-telescoping steering wheel. Adjustable control lever stands for swing, boom elevating, boom telescoping, auxiliary winch and main winch. Control lever stands can change neutral positions and tilt for easy access to cab. 3 way adjustable operator's seat with high back, headrest and armrest. Engine throttle knob. Foot operated controls: boom elevating boom telescoping, service brake and engine throttle. Hot water cab heater and air conditioning.

Dash-mounted engine start/stop, monitor lamps, cigarette lighter, drive selector switch, parking brake switch, steering mode select switch, power window switch, pump engaged/ disengaged switch, swing brake switch, telescoping/auxiliary winch select switch, outrigger controls, free swing / lock swing selector switch, eco mode switch, high speed winch (main/aux) switch and ashtray.

Instruments - Torque converter oil temperature, engine water temperature, air pressure, fuel, speedometer, tachometer, hour meter and odometer / tripmeter. Hydraulic oil pressure is monitored and displayed on the AML-C display panel.

CRANE SPECIFICATIONS

Tadano electronic LOAD MOMENT INDICATOR system (AML-C) including:

- Control lever lockout function with audible and visual pre-warning
- Boom position indicator
- Outrigger state indicator
- Boom angle / boom length / jib offset angle / jib length / load radius / rated lifting capacities / actual loads read out
- Ratio of actual load moment to rated load moment indication
- Automatic speed reduction and slow stop function on boom elevation and slewing
- Working condition register switch
- Load radius / boom angle / tip height / slewing range preset function
- External warning lamp
- Tare function
- Fuel consumption monitor
- Main winch / auxiliary winch select
- Drum rotation indicator (audible and visible type) main and auxiliary winch

TADANO AML-C monitors outrigger extended length and automatically programs the corresponding "RATED LIFTING CAPACITIES" table.

Operator's right hand console includes transmission gear selector and sight level bubble. Upper console includes working light switch, roof washer and wiper switch emergency outrigger set up key switch, jib equipped/removed select switch, eco mode switch, high speed winch (main / aux) switch, Cab tilt switch. Slewing lock lever.

NOTE: Each crane motion speed is based on unladen conditions.

CARRIER SPECIFICATIONS

TYPE

Rear engine, left hand steering, driving axle 2-way selected type by manual switch, 4x2 front drive, 4x4 front and rear drive.

FRAME

High tensile steel, all welded mono-box construction.

ENGINE

Model	Cummins QSB6.7 EPA)Tier4 Final
Type	Direct injection diesel
No. of cylinders	6
Combustion	4 cycle, turbo charged and after cooled
Bore x Stroke, in. (mm)	4.212 x 4.882 (107 x 124)
Displacement, cu. in (liters)	409 (6.700)
Air inlet heater	24 volt preheat
Air cleaner	Dry type, replaceable element
Oil filter	Full flow with replaceable element
Fuel filter	Full flow with replaceable element
Fuel tank, gal. (liters)	79.2 (300), right side of carrier
Cooling	Liquid pressurized, recirculating by-pass
Radiator	Fin and tube core, thermostat controlled
Fan, in. (mm)	Suction type, 9-blade, 28 (711) dia.
Starting	24 volt
Charging	24 volt system, negative ground
Battery	2-120 amp. Hour
Compressor, air, CFM (l /min)	17.0 CFM (481) at 2,400 rpm
Output, Max. HP (kW)	Gross 270 (201) at 2,000 rpm
Torque, Max. ft-lb (Nm)	730 (990) at 1,500 rpm
Capacity, gal. (liters)	
Cooling water	2.7 (10)
Lubrication	4.0 (15)
Fuel	79.2 (300)
DEF / AdBlue	10.0 (38)

TRANSMISSION

Electronically controlled full automatic transmission. Torque converter driving full powershift with driving axle selector. 5 forward and 2 reverse speeds, constant mesh.
2 speeds - high range - 2 wheel drive; 4 wheel drive
3 speeds - low range - 4 wheel drive

TRAVEL SPEED

12 mph (19 km/h)

GRADE ABILITY (tan θ) - 84%, 57%*

* Machine should be operated within the limit of engine crankcase design (30°: Cummins QSB6.7 EPA)Tier4 Final)

AXLE

Front: Full floating type, steering and driving axle with planetary reduction.

Rear: Full floating type, steering and driving axle with planetary reduction and non-spin rear differential.

STEERING

Hydraulic power steering controlled by steering wheel. Four steering modes available: 2 wheel front, 2 wheel rear, 4 wheel coordinated and 4 wheel crab.

SUSPENSION

Front: Rigid mounted to frame.

Rear: Pivot mounted with hydraulic lockout device.

BRAKE SYSTEMS

Service: Air over hydraulic disc brakes on all 4 wheels.

Parking/Emergency: Spring applied-air released brake acting on input shaft of front axle.

Auxiliary: Electro- pneumatic operated exhaust brake.

TIRES - 29.5-25 34PR (OR) Air pressure: 57 psi (400 kPa)

OUTRIGGERS

Four hydraulic, beam and jack outriggers. Vertical jack cylinders equipped with integral holding valve. Each outrigger beam and jack is controlled independently from cab. Beams extend to 23' 11-3/8" (7.3 m) center-line and retract to within 10' 10-1 / 2" (3.315 m) overall width with floats. Outrigger jack floats are attached thus eliminating the need of manually attaching and detaching them. Controls and sight bubble located in superstructure cab. Four outrigger extension lengths are provided with corresponding "RATED LIFTING CAPACITIES" for crane duty in confined areas.

Min. Extension	8' 10-1 / 4" (2.7 m) center to center
Mid. Extension	18' 1 / 2" (5.5 m) center to center
Mid. Extension	21' 11-3 / 4" (6.7 m) center to center
Max. Extension	23' 11-3 / 8" (7.3 m) center to center

Float size (Diameter) 1' 11- 5 / 8" (0.6 m)

STANDARD EQUIPMENT

- Six section extended boom by single telescoping cylinder 39.4'-183.7' (12.0 m-56.0 m)
- 33.2' (10.1 m) or 58.1' (17.7 m) bi-fold lattice jib with 3.5°, 25° or 45° pinned offsets and self stowing pins.
- Quick reeving type bi-fold jib
- Anti-Two block device (overwind cutout)
- Mirror for main and auxiliary winch
- Work lights
- Variable speed main winch with grooved drum, cable follower and 771' of 3/4" (235 m of 19 mm) cable.
- Variable speed auxiliary winch with grooved drum, cable follower and 518' of 3/4" (158 m of 19 mm) cable.
- Drum rotation indicator (audible, visible and thumper type) main and auxiliary winch
- Auxiliary lifting sheave (single top) stowable
- 2-speed winch
- Tadano twin swing system and 360° positive swing lock
- Positive control
- Hydraulic oil cooler
- 15° tilt cab
- 3 way adjustable cloth seat with armrests, high back and seat belt
- Tilt-telescoping steering wheel
- Tinted safety glass and sun visor
- Front windshield wiper and washer
- Roof window wiper and washer
- Power window (cab door)
- Cigarette lighter and ashtray
- Cab floor mat
- Pump disconnect in operator's cab
- Air conditioner (hot water heater and cooler)
- Full instrumentation package
- Self centering finger control levers with pilot control
- Control pedals for boom elevating and boom telescoping
- Low oil pressure/high water temp. warning device (visual)
- Rear steer centering light
- Air cleaner dust indicator
- Tadano electronic load moment indicator system (AML-C)
- Tare function
- Boom angle indicator
- Outrigger extension length detector
- Electronic crane monitoring system
- Rear view mirrors (right and left side)
- Fenders
- Air dryer
- Complete highway light package
- Towing hooks-Front and rear
- Hook block tie down (front bumper)
- Weighted hook storage compartment
- Halogen head lamp
- Independently controlled outriggers
- Four outrigger extension positions
- Self-storing outrigger pads
- Electronic controlled automatic transmission driven by torque converter
- 4 x 4 x 4 drive/steer
- Non-spin rear differential
- Automatic rear axle oscillation lockout system
- 26.5R25☆☆ tires
- Disc brakes
- Water separator with filter (high filtration)
- Back-up alarm
- 24 volt electric system
- Tool storage compartment
- Tire inflation kit
- Cummins QS 6.7 turbo charged after cooled engine (270 HP) with exhaust brake
- Engine over-run alarm
- Lifting eyes
- Telematics(machine data logging and monitoring system) with HELLO-NET via internet (availability depends on countries)
- Fuel consumption monitor
- Eco mode system
- Self-removable counterweight
- 7.9 ton (7.2 metric ton) - Weighted hook with swivel and safety latch
- Radiator cover

OPTIONAL EQUIPMENT

- Working lamp with remot controller
- Boom and jib mounted aircraft warning light
- Wind speed indicator
- Emergency steering system
- Over-unwinding prevention
- Engine oil pan heater
- Engine coolant heater
- 50 ton (45 metric ton) - 3 sheaves with hook block and safety latch
- 77 ton (70 metric ton) - 3 sheaves with hook block and safety latch
- 120 ton (110 metric ton) - 7 sheaves with hook block and safety latch

HOISTING PERFORMANCE

LINE SPEEDS AND PULLS

Layer	Main or auxiliary winch - 15" (0.382 m) drum					
	Line speeds ¹				Line pulls Available ²	
	Low		High		Low	
	F.P.M	m/min	F.P.M	m/min	Lbs.	kgf
1st	253	77	354	108	21,800	9,900
2nd	276	84	384	117	19,900	9,010
3rd	299	91	413	126	18,200	8,270
4th	318	97	446	136	16,800	7,640
5th	341	104	476	145	15,600	7,090
6th	361	110	505	154	14,600	6,620
7th ³	384	117	535	163	13,700	6,210

- Maximum permissible line pull wire strength. 15,900 lbs (7,200 kg) with 7 x 35 class rope.

¹ Line speed based only on hook block, not loaded.
² Developed by machinery with each layer of wire rope, but not based on rope strength or other limitations in machinery or equipment.
³ Seventh layer of wire rope are not recommended for hoisting operations.

DRUM WIRE ROPE CAPACITIES

Wire rope layer	Main and auxiliary drum grooved lagging			
	3/4" (19 mm) wire rope			
	Rope per layer		Total wire rope	
	Feet	Meter	Feet	Meter
1	147.0	44.8	147.0	44.8
2	159.4	48.6	306.4	93.4
3	172.2	52.5	478.7	145.9
4	184.7	56.3	663.4	202.2
5	197.2	60.1	860.6	262.3
6	209.6	63.9	1070.2	326.2
7	222.1	67.7	1292.3	393.9

DRUM DIMENSIONS (Main and auxiliary)

	Inch	mm
Root diameter	15	382
Length	29-1/4	742
Flange diameter	26-5/8	677

GR-1200XL WORKING RANGE CHART

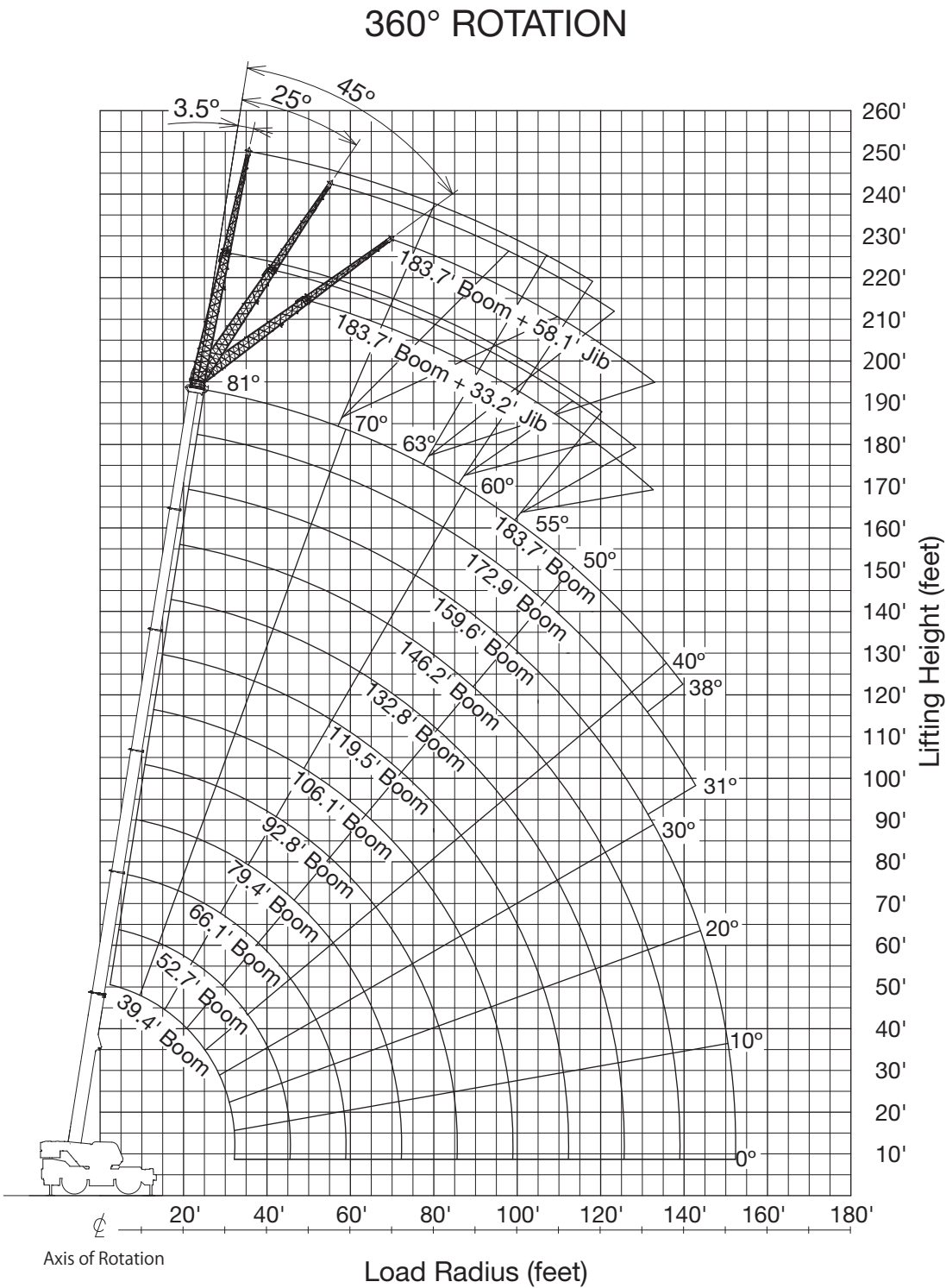

BOOM

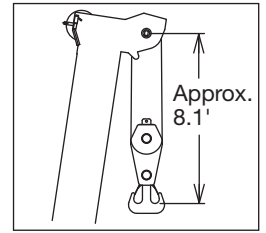

JIB

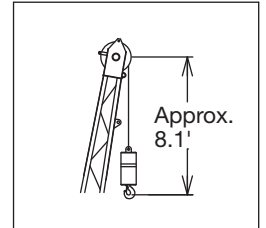

SINGLE TOP

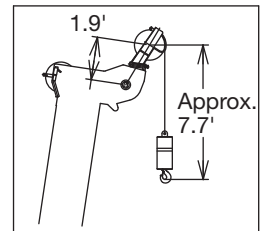

NOTE: Boom and jib geometry shown are for unloaded condition and machine standing level on firm supporting surface. Boom deflection and subsequent radius and boom angle change must be accounted for when applying load to hook.

GR-1200XL WORKING RANGE CHART

SMART CHART

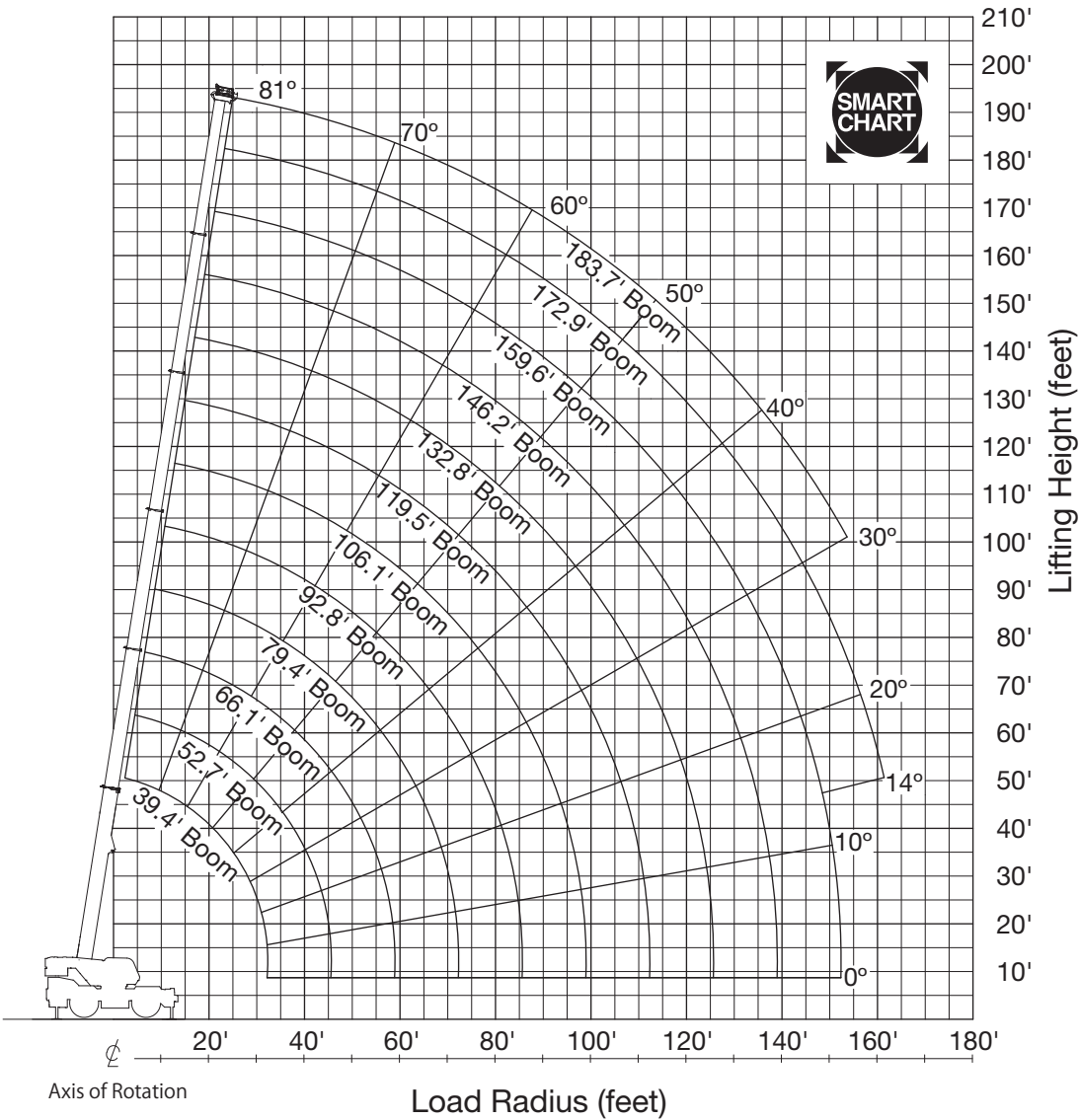

BOOM

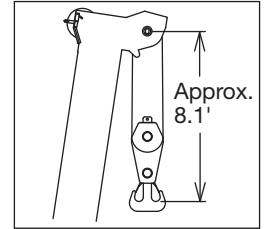

SINGLE TOP

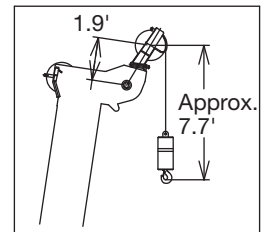

NOTE: Boom and jib geometry shown are for unloaded condition and machine standing level on firm supporting surface. Boom deflection and subsequent radius and boom angle change must be accounted for when applying load to hook.

GR-1200XL RATED LIFTING CAPACITIES (IN POUNDS)

COUNTERWEIGHT 22,000 lbs (10.0 t) ON OUTRIGGERS FULLY EXTENDED 23'11-3/8" (7.3 m) SPREAD 360° ROTATION												
B \ A	39.4' (12.0 m)	57.2' (17.4 m)	66.1' (20.1 m)	79.4' (24.2 m)	92.8' (28.3 m)	106.1' (32.4 m)	119.5' (36.4 m)	132.8' (40.5 m)	146.2' (44.6 m)	159.6' (48.6 m)	172.9' (52.7 m)	183.7' (56.0 m)
8'	*242,500	143,300										
10'	180,300	143,300	136,900									
12'	159,000	143,300	127,400	106,300								
15'	133,200	132,700	115,300	106,300	80,700							
20'	101,400	100,500	101,400	102,300	71,700	60,400	41,000					
25'	78,000	77,200	77,800	78,700	65,700	56,200	45,600	37,300				
30'	60,800	59,700	60,800	61,900	60,400	56,200	43,900	37,300	31,700			
35'		45,600	50,700	52,900	52,500	51,600	40,100	35,700	30,900	25,600	20,700	
40'		39,900	41,400	41,900	41,400	40,600	36,800	32,800	28,900	25,600	20,700	18,100
45'		32,200	33,700	34,200	33,700	32,800	34,200	30,000	26,900	24,300	20,700	18,100
50'			28,200	28,400	28,000	27,300	28,400	26,500	24,900	22,700	20,500	18,100
55'			23,800	24,300	23,800	22,900	24,000	23,800	22,500	21,400	19,600	17,900
60'				21,800	20,300	20,700	20,500	21,200	19,400	19,600	18,500	17,000
65'				19,000	18,700	19,400	17,900	18,500	18,300	18,300	17,400	16,300
70'				16,800	16,800	17,200	15,900	16,800	16,300	15,900	15,200	15,200
75'					15,000	15,200	15,000	15,000	14,300	13,900	13,200	13,200
80'					13,200	13,400	13,200	13,200	12,800	12,300	11,500	11,500
85'					11,900	12,100	11,900	11,700	11,200	10,800	10,100	10,100
90'						10,800	10,600	10,600	9,900	9,500	8,800	8,800
95'						9,700	9,500	9,300	8,800	8,400	7,700	7,700
100'							8,400	8,400	7,900	7,500	6,800	6,800
105'							7,700	7,500	7,100	6,600	6,000	6,000
110'							6,800	6,600	6,200	5,700	5,100	5,100
115'								6,000	5,500	5,100	4,400	4,400
120'								5,300	4,900	4,400	3,700	3,700
125'								4,900	4,200	4,000	3,300	3,100
130'									3,700	3,300	2,600	2,600
135'									3,300	2,900	2,200	2,200
140'										2,400		
145'										2,000		

COUNTERWEIGHT 22,000 lbs (10.0 t) ON OUTRIGGERS FULLY EXTENDED 23'11-3/8" (7.3 m) SPREAD Smart Chart												
B \ A	39.4' (12.0 m)	57.2' (17.4 m)	66.1' (20.1 m)	79.4' (24.2 m)	92.8' (28.3 m)	106.1' (32.4 m)	119.5' (36.4 m)	132.8' (40.5 m)	146.2' (44.6 m)	159.6' (48.6 m)	172.9' (52.7 m)	183.7' (56.0 m)
8'	*242,500	143,300										
10'	180,300	143,300	136,900									
12'	159,000	143,300	127,400	106,300								
15'	133,200	132,700	115,300	106,300	80,700							
20'	101,400	100,500	101,400	102,300	71,700	60,400	41,000					
25'	78,000	77,200	77,800	78,700	65,700	56,200	45,600	37,300				
30'	60,800	59,700	60,800	61,900	60,400	56,200	43,900	37,300	31,700			
35'		47,200	50,700	53,100	53,400	52,500	40,100	35,700	30,900	25,600	20,700	
40'		41,700	44,100	44,500	44,100	43,400	36,800	32,800	28,900	25,600	20,700	18,100
45'		35,700	37,300	37,700	37,300	36,400	34,400	30,000	26,900	24,300	20,700	18,100
50'			32,000	32,200	31,700	31,100	32,200	27,800	24,900	22,700	20,500	18,100
55'			27,600	28,000	27,600	26,700	28,000	25,800	23,100	21,400	19,600	17,900
60'				24,500	24,000	23,400	24,500	22,500	21,400	19,800	18,500	17,000
65'				21,600	20,900	20,100	21,200	21,200	19,800	18,700	17,400	16,300
70'				19,800	18,300	18,100	18,500	19,200	17,200	17,400	16,500	15,400
75'					16,500	17,200	16,300	17,000	16,300	16,500	15,700	14,600
80'					15,900	16,100	14,300	15,000	15,200	14,800	14,100	13,900
85'					14,100	14,300	13,200	14,100	13,400	13,000	12,300	12,300
90'						13,000	12,600	12,600	12,100	11,700	11,000	11,000
95'						11,700	11,500	11,200	10,800	10,400	9,700	9,700
100'							10,400	10,100	9,700	9,300	8,600	8,600
105'							9,300	9,300	8,800	8,400	7,700	7,700
110'							8,600	8,400	7,900	7,500	6,800	6,800
115'								7,500	7,100	6,600	6,000	6,000
120'								6,800	6,400	6,000	5,300	5,300
125'								6,200	5,700	5,300	4,600	4,600
130'									5,100	4,600	4,000	4,000
135'									4,600	4,200	3,500	3,500
140'										3,500	2,900	2,900
145'										3,100	2,400	2,400
150'										2,900	2,000	2,000

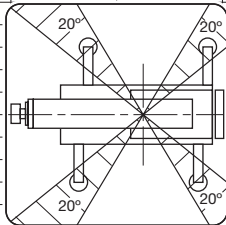

*Over front with special Equipment

A: Boom length in feet
B: Load radius in feet

Note: The lifting capacity data stored in the LOAD MOMENT INDICATOR (AML-C) is based on the standard number of parts of line listed in the chart. Standard number of parts of line for each boom length should be according to the following table.

GR-1200XL RATED LIFTING CAPACITIES (IN POUNDS)

COUNTERWEIGHT 22,000 lbs (10.0 t) ON OUTRIGGERS FULLY EXTENDED 23'11-3/8" (7.3 m) SPREAD 360° ROTATION													
C	183.7' (56.0 m) + 33.2' (10.1 m) Manual offset jib						C	172.9' (52.7 m) Boom + 33.2' (10.1 m) Manual offset jib					
	3.5° Tilt		25° Tilt		45° Tilt			3.5° Tilt		25° Tilt		45° Tilt	
	R	W	R	W	R	W		R	W	R	W	R	W
81	45.7'	9,900	57.0'	8,600	67.2'	7,900	81	43.7'	11,000	55.0'	9,500	63.5'	8,400
80	50.2'	9,900	60.8'	8,400	70.8'	7,700	80	47.4'	11,000	58.2'	9,300	66.8'	8,400
79	54.6'	9,700	64.8'	8,200	74.5'	7,500	79	51.2'	10,800	61.8'	9,000	70.1'	8,200
78	59.0'	9,500	68.5'	7,900	78.0'	7,300	78	55.3'	10,600	65.4'	8,800	73.4'	7,900
77	62.6'	9,000	72.5'	7,700	82.0'	7,100	77	57.7'	10,100	68.9'	8,600	77.0'	7,700
76	66.8'	8,800	76.6'	7,700	85.0'	7,100	76	62.6'	9,900	72.4'	8,400	80.0'	7,500
75	71.2'	8,600	80.4'	7,500	89.0'	6,800	75	66.2'	9,700	75.9'	8,200	83.0'	7,500
73	79.0'	8,200	88.0'	7,100	96.0'	6,600	73	73.3'	9,000	83.0'	7,700	90.0'	7,300
70	91.0'	7,500	99.0'	6,600	106.0'	6,400	70	84.1'	8,400	93.0'	7,300	100.0'	6,800
68	99.0'	7,100	106.0'	6,400	113.0'	6,200	68	91.0'	7,900	100.0'	7,100	106.0'	6,600
65	108.0'	5,500	115.0'	5,100	122.0'	5,100	65	101.0'	7,100	110.0'	6,400	115.0'	6,200
63	113.0'	4,400	121.0'	4,200	127.0'	4,200	63	107.0'	6,000	116.0'	5,300	120.0'	5,300
60	122.0'	3,300	129.0'	3,300	135.0'	3,300	60	116.0'	4,600	123.0'	4,200	127.0'	4,200
58	127.0'	2,600	134.0'	2,600	140.0'	2,600	58	121.0'	3,700	130.0'	3,500	132.0'	3,500
55	135.0'	1,800	142.0'	1,800			55	129.0'	2,900	135.0'	2,600	139.0'	2,600
53							53	134.0'	2,200	140.0'	2,200	143.0'	2,200
50							50	141.0'	1,500	147.0'	1,500		

COUNTERWEIGHT 22,000 lbs (10.0 t) ON OUTRIGGERS FULLY EXTENDED 23'11-3/8" (7.3 m) SPREAD 360° ROTATION													
C	159.6' (48.6 m) Boom + 33.2' (10.1 m) Manual offset jib						C	106.1'(32.4 m) Boom + 33.2' (10.1 m) Manual offset jib					
	3.5° Tilt		25° Tilt		45° Tilt			3.5° Tilt		25° Tilt		45° Tilt	
	R	W	R	W	R	W		R	W	R	W	R	W
81	39.9'	13,200	51.3'	11,500	59.7'	9,900	81	22.7'	14,600	36.6'	14,600	43.0'	10,800
80	43.3'	13,200	54.3'	11,000	62.6'	9,700	80	25.4'	14,600	39.0'	14,100	45.5'	10,600
79	47.4'	13,200	57.6'	10,800	65.9'	9,700	79	27.9'	14,600	41.6'	13,900	47.9'	10,600
78	51.0'	13,000	60.9'	10,600	69.0'	9,500	78	30.6'	14,600	44.2'	13,400	50.1'	10,400
77	54.3'	12,600	64.2'	10,400	72.0'	9,300	77	33.3'	14,600	46.7'	13,200	52.2'	10,100
76	57.6'	12,100	67.5'	10,100	75.0'	9,000	76	35.8'	14,600	49.2'	12,800	54.4'	10,100
75	61.0'	11,900	70.7'	9,900	79.0'	9,000	75	38.4'	14,600	51.5'	12,600	56.5'	9,900
73	67.5'	11,000	77.5'	9,500	84.0'	8,600	73	43.5'	14,600	56.0'	12,100	60.6'	9,900
70	77.6'	10,100	87.0'	9,000	94.0'	8,400	70	51.0'	14,600	62.9'	11,700	66.7'	9,700
68	84.2'	9,700	93.0'	8,600	100.0'	8,200	68	55.8'	14,600	67.2'	11,200	70.6'	9,500
65	93.0'	8,200	102.0'	7,300	107.0'	7,100	65	62.5'	14,600	73.5'	10,800	76.2'	9,300
63	99.0'	7,100	107.0'	6,400	112.0'	6,200	63	67.0'	14,600	77.5'	10,600	80.2'	9,300
60	107.0'	5,500	115.0'	5,100	118.0'	4,900	60	73.3'	13,700	83.0'	10,400	85.4'	9,300
58	113.0'	4,600	119.0'	4,400	123.0'	4,200	58	77.5'	13,200	87.0'	10,400	88.8'	9,300
55	120.0'	3,500	126.0'	3,300	129.0'	3,300	55	83.4'	12,600	93.0'	10,100	93.8'	9,000
53	124.0'	3,100	131.0'	2,900	134.0'	2,900	53	86.9'	11,500	96.0'	9,900	96.9'	9,000
50	131.0'	2,200	137.0'	2,200	140.0'	2,200	50	92.2'	9,900	101.0'	9,000	101.0'	8,800
48	136.0'	1,800	141.0'	1,800	144.0'	1,800	48	95.6'	9,000	104.0'	8,400	104.0'	8,200
45	142.0'	1,300					45	100.0'	8,200	108.0'	7,500	108.0'	7,300
43							43	104.0'	7,500	110.0'	7,100		
40							40	108.0'	6,600	114.0'	6,400		
38							38	111.0'	6,200	116.0'	6,000		
35							35	115.0'	5,700	120.0'	5,500		
33							33	117.0'	5,300	122.0'	5,100		
30							30	121.0'	4,900	124.0'	4,600		
25							25	125.0'	4,200	128.0'	4,200		
20							20	129.0'	3,700				
15							15	132.0'	3,500				
10							10	134.0'	3,300				

C: Loaded boom angle (°)
R: Load radius in feet
W: Rated lifting capacity in pounds

NOTE: The lifting capacity data stored in the LOAD MOMENT INDICATOR (AML-C) is based on the standard number of parts of line listed in the chart.

GR-1200XL RATED LIFTING CAPACITIES (IN POUNDS)

COUNTERWEIGHT 22,000 lbs (10.0 t) ON OUTRIGGERS FULLY EXTENDED 23'11-3/8" (7.3 m) SPREAD 360° ROTATION													
C	183.7' (56.0 m) Boom + 58.1' (17.7 m) Manual offset jib						C	172.9' (52.7 m) Boom + 58.1' (17.7 m) Manual offset jib					
	3.5° Tilt		25° Tilt		45° Tilt			3.5° Tilt		25° Tilt		45° Tilt	
	R	W	R	W	R	W		R	W	R	W	R	W
81	53.1'	6,400	75.3'	6,000	89.8'	5,100	81	50.0'	6,800	69.8'	6,200	86.1'	5,100
80	58.1'	6,400	79.8'	5,700	93.7'	4,900	80	54.0'	6,800	75.0'	6,200	89.7'	5,100
79	63.4'	6,400	84.0'	5,500	98.0'	4,900	79	59.0'	6,800	78.9'	6,000	93.3'	5,100
78	68.2'	6,400	88.8'	5,500	102.0'	4,900	78	63.5'	6,800	82.6'	5,700	96.9'	4,900
77	73.6'	6,400	93.0'	5,300	106.0'	4,600	77	68.1'	6,800	86.8'	5,700	101.0'	4,900
76	78.8'	6,400	97.3'	5,300	110.0'	4,600	76	72.6'	6,800	90.9'	5,500	104.0'	4,900
75	83.3'	6,200	101.4'	5,100	114.0'	4,600	75	77.2'	6,800	94.9'	5,500	107.0'	4,600
73	93.0'	6,000	110.0'	4,900	121.0'	4,400	73	85.9'	6,600	103.0'	5,300	114.0'	4,600
70	106.4'	5,500	122.0'	4,600	131.0'	4,200	70	98.9'	6,200	114.0'	5,100	124.0'	4,400
68	114.0'	4,900	129.0'	4,200	138.0'	4,000	68	107.0'	5,700	122.0'	4,900	131.0'	4,400
65	123.0'	3,500	138.0'	3,100	146.0'	2,900	65	118.0'	4,900	132.0'	4,200	140.0'	3,700
63	129.0'	2,600	144.0'	2,400	152.0'	2,400	63	124.0'	4,000	137.0'	3,300	145.0'	3,300
60	138.0'	1,800					60	132.0'	2,900	145.0'	2,400	152.0'	2,400
58							58	138.0'	2,200	150.0'	2,000	157.0'	2,000
55							55	146.0'	1,500				

COUNTERWEIGHT 22,000 lbs (10.0 t) ON OUTRIGGERS FULLY EXTENDED 23'11-3/8" (7.3 m) SPREAD 360° ROTATION													
C	159.6' (48.6 m) Boom + 58.1' (17.7 m) Manual offset jib						C	106.1' (32.4 m) Boom + 58.1' (17.7 m) Manual offset jib					
	3.5° Tilt		25° Tilt		45° Tilt			3.5° Tilt		25° Tilt		45° Tilt	
	R	W	R	W	R	W		R	W	R	W	R	W
81	46.3'	7,700	66.3'	6,600	80.7'	5,300	81	30.1'	9,900	51.8'	7,300	64.7'	5,300
80	50.1'	7,700	70.2'	6,600	83.8'	5,100	80	33.3'	9,900	54.7'	7,100	67.2'	5,100
79	54.7'	7,700	73.9'	6,400	87.6'	5,100	79	36.5'	9,900	57.4'	6,800	69.6'	5,100
78	58.9'	7,700	77.5'	6,200	90.9'	5,100	78	39.7'	9,900	60.0'	6,600	72.0'	5,100
77	63.1'	7,700	81.3'	6,200	94.0'	4,900	77	42.8'	9,900	62.8'	6,600	74.4'	4,900
76	67.2'	7,700	84.8'	6,000	97.3'	4,900	76	46.0'	9,900	65.5'	6,400	76.6'	4,900
75	71.8'	7,700	88.9'	6,000	101.0'	4,900	75	48.8'	9,900	68.2'	6,400	79.0'	4,900
73	80.0'	7,700	96.1'	5,700	107.0'	4,900	73	54.7'	9,900	73.6'	6,200	83.6'	4,900
70	91.7'	7,300	106.0'	5,300	117.0'	4,600	70	63.0'	9,000	80.8'	5,700	89.9'	4,600
68	99.8'	7,100	114.0'	5,100	123.0'	4,600	68	68.1'	8,400	85.9'	5,500	94.3'	4,600
65	110.0'	6,000	124.0'	5,100	132.0'	4,400	65	76.1'	7,900	92.8'	5,300	100.0'	4,400
63	116.0'	5,100	130.0'	4,400	137.0'	4,000	63	80.9'	7,500	97.6'	5,300	104.0'	4,400
60	124.0'	3,700	137.0'	3,300	143.0'	3,100	60	88.5'	7,100	104.0'	5,100	110.0'	4,400
58	129.0'	3,100	142.0'	2,900	148.0'	2,600	58	93.4'	7,100	108.0'	5,100	113.0'	4,400
55	137.0'	2,200	149.0'	2,000	154.0'	2,000	55	100.0'	6,600	114.0'	4,900	118.0'	4,400
53	142.0'	1,800	154.0'	1,500			53	105.0'	6,400	118.0'	4,900	121.0'	4,200
50							50	111.0'	6,200	124.0'	4,600	126.0'	4,200
48							48	115.0'	6,000	127.0'	4,600	128.0'	4,200
45							45	121.0'	5,700	132.0'	4,600	132.0'	4,200
43							43	125.0'	5,300	135.0'	4,600		
40							40	130.0'	4,900	139.0'	4,400		
38							38	133.0'	4,400	141.0'	4,000		
35							35	137.0'	4,000	144.0'	3,700		
33							33	140.0'	3,700	146.0'	3,500		
30							30	144.0'	3,300	149.0'	3,100		
25							25	149.0'	2,900	152.0'	2,600		
20							20	154.0'	2,600				
15							15	157.0'	2,200				
10							10	159.0'	2,200				

C: Loaded boom angle (°)
R: Load radius in feet
W: Rated lifting capacity in pounds

NOTE: The lifting capacity data stored in the LOAD MOMENT INDICATOR (AML-C) is based on the standard number of parts of line listed in the chart.

GR-1200XL RATED LIFTING CAPACITIES (IN POUNDS)

WARNING AND OPERATING INSTRUCTIONS FOR ON RUBBER LIFTING CAPACITIES

NOTES FOR ON-RUBBER LIFTING CAPACITIES

1. Rated lifting capacities on-rubber are in pounds and do not exceed 75% of tipping loads as determined by SAE J765-Crane Stability Test Code.
 2. Rated lifting capacities shown in The chart are based on condition that crane is set on firm level surfaces with suspension-lock applied. Those above thick lines are based on tire capacity and those below, on crane stability. They are based on actual load radius increased by tire deformation and boom deflection.
 3. If the suspension-lock cylinders contain air,The axle will not be locked completely and rated lifting capacities may not be obtainable. Bleed the cylinders according to the operation safety and maintenance manual.
 4. Rated lifting capacities are based on proper tire inflation, capacity and condition. Damaged tires are hazardous to safe operation of crane.
 5. Tires shall be inflated to correct air pressure.
- | Tires | Air Pressure |
|--------------|-------------------|
| 29.5-25 34PR | 57 psi. (400 kPa) |
6. Over front operation shall be performed within 2 degrees in front of chassis.
 7. On-rubber lifting with "jib" is not permitted. Maximum permissible boom length is 92.8' (28.3 m).
 8. When making lift on-rubber stationary,set parking brake.
 9. For creep operation,boom must be centered over front of machine,slewing lock engaged, and load restrained from slewing. Travel slowly and keep the lifted load as close to the ground as possible,and especially avoid any abrupt steering,accelerating or braking.
 10. Do not operate the crane while carrying the load.
 11. Creep is motion for crane not to travel more than 200 ft. (60 m) in any 30 minute period and to travel at the speed of less than 1 mph (1.6 km/h).
 12. For creep operation,choose the drive mode and proper gear according to the road or working condition.
 13. The mass of the hook (2380 lbs (1080 kg) for 120 ton(110 metric ton)capacity, 660 lbs (300 kg)for 7.9 ton (7.2 metric ton) capacity), slings and all similarly used load handling devices must be considered as part of the load and must be deducted from the lifting capacities.
 15. For rated lifting capacity of single top, reduce the rated lifting capacities of relevant boom according to a weight reductions for auxiliary load handling equipment. Capacities of single top shall not exceed 15,900 lbs (7,200 kg) including main hook.
 16. The lifting capacity data stowed in the Automatic Moment Limiter (AML-C) is based on the standard number of parts of line listed in the chart. Standard number of parts of line for on rubber operation should be according to the following table.

WARNING AND OPERATING INSTRUCTIONS

NOTES FOR LIFTING CAPACITIES

GENERAL

1. RATED LIFTING CAPACITIES apply only to the machine as originally manufactured and normally equipped by TADANO LTD. Modifications to the machine or use of optional equipment other than that specified can result in a reduction of capacity.
2. Hydraulic cranes can be hazardous if improperly operated or maintained. Operation and maintenance of this machine must be in compliance with information, in the Operation and Maintenance Manual supplied with the crane. If this manual is missing, order a replacement through the distributor.
3. The operator and other personnel associated with this machine shall fully acquaint themselves with the latest American National Standards Institute (ANSI) safety standards for cranes.

SET UP

1. Rated lifting capacities on the chart are the maximum allowable crane capacities and are based on the machine standing level on firm supporting surface under ideal job conditions. Depending on the nature of the supporting surface, it may be necessary to have structural supports under the outrigger floats or tires to spread the loads to a larger bearing surface.
2. For outrigger operation, outriggers shall be properly extended with tires free of supporting surface before operating crane.

OPERATION

1. Rated lifting capacities have been tested to and meet minimum requirements of SAE J1063-Cantilevered Boom Crane Structures Method of Test.
2. Rated lifting capacities do not exceed 85% of the tipping load on outriggers fully extended as determined by SAE J765-Crane Stability Test Code.
Rated lifting capacities FOR partially extended outriggers are determined from the formula, Rated Lifting Capacities=(Tipping Load-0.1×Tip Reaction)/1.25.
3. Rated lifting capacities above thick lines in the chart are based on crane strength and those below, on its stability. They are based on actual load radius increased by boom deflection.
4. The weight of handling device such as hook blocks, slings, etc., must be considered as part of the load and must be deducted from the lifting capacities.
5. Rated lifting capacities are based on freely suspended loads and make no allowance for such factors as the effect of wind, sudden stopping of loads, supporting surface conditions, inflation of tires, operating speeds, side loads, etc. Side pull on the boom or jib is extremely dangerous.
Such action can damage the boom, jib or swing mechanism, and lead to overturning of the crane.
6. Rated lifting capacities do not account for wind on lifted load or boom. We recommend against working under the condition that the load is out of control due to a strong wind. During boom lift, consider that the rated lifting capacity is reduced by 50% when the wind speed is 20 mph (9 m/s) to 27 mph (12 m/s); reduced by 70% when the wind speed is 27 mph (12 m/s) to 31 mph (14 m/s). If the wind speed is 31 mph (14 m/s) or over, stop operation. However, in the following conditions, stop operation at wind speed of 27 mph (12 m/s): Boom length is 183.7' (56.0 m) (all 100%), and boom angle is 55° or less. Boom length is 172.9' (52.7 m) (all 92%), and boom angle is 45° or less.
During jib lift, stop operation if the wind speed is 20 mph (9 m/s) or over.

7. Rated lifting capacities at load radius shall not be exceeded. Do not tip the crane to determine allowable loads.
8. Do not operate at boom lengths, radii, or boom angle, where no capacities are shown. Crane may overturn without any load on the hook.
9. When boom length is between values listed, refer to the rated lifting capacities of the next longer and next shorter booms for the same radius. the lesser of the two rated lifting capacities shall be used.
10. When making lifts at a load radius not shown, use the next longer radius to determine allowable capacity.
11. Load per line should not exceed 15,900 lbs. (7,200 kg) for main winch and auxiliary winch.
12. Check the actual number of parts of line with LOAD MOMENT INDICATOR (AML-C) before operation. Maximum lifting capacity is restricted by the number of parts of line of LOAD MOMENT INDICATOR (AML-C). Limited capacity is as determined FROM the formula, Single line pull for main winch 15,900 lbs. (7,200 kg) x number of parts of line.
13. The boom angle before loading should be greater to account for deflection. For rated lifting capacities, the loaded boom angle and the load radius is for reference only.
14. Maximum capacity without boom pin is shown in the chart.
15. Do not operate extension or retraction of the boom with loads.
16. For lifting capacity of single top, deduct the weight of the load handling equipment from the rated lifting capacity of the boom. For the lifting capacity of single top, the net capacity shall not exceed 15,900 lbs. (7,200 kg) including main boom hook mass attached to the boom.
17. When the base jib or top jib or both jibs are removed, set the jib status switch to the DISMOUNTED position.
18. When erecting and stowing jib, be sure to retain it by hand or by other means to prevent its free movement.
19. Use "ANTI-TWO-BLOCK" disable switch when erecting and stowing jib and when stowing hook block.
While the switch is pushed, the hoist does not stop, even when overwind condition occurs.
20. For selected boom length or less with jib, rated lifting capacities are determined by loaded boom angle only in the column headed "selected boom + jib".
21. Crane operation is prohibited without full counterweight 22,000 lbs. (10 ton) installed. Outriggers shall be extended 23'11 3/8" (7.3 m) spread when installing or removing removable counterweight.

DEFINITIONS

1. Load Radius: Horizontal distance from a projection of the axis of rotation to supporting surface before loading to the center of the vertical hoist line or tackle with load applied.
2. Loaded boom angle: THE angle between the boom base section and the horizontal, after lifting the rated lifting capacity at the load radius.
3. Working Area: Area measured in a circular arc about the centerline of rotation.
4. Freely suspended Load: Load hanging free with no direct external force applied except by the hoist line.
5. Side Load: Horizontal side force applied to the lifted load either on the ground or in the air.

NOTES FOR LOAD MOMENT INDICATOR (AML-C)

- Set AML select keys in accordance with the actually operating crane conditions and don't fail to make sure, before crane operation, that the displays on front panel are correct.
- When operating crane on outriggers:
 - Set "P.T.O." switch to "ON".
 - Press the outrigger state select key to register for the outrigger operation. If the display agrees with the actual state, press the set key to register. After the completion of the registration, the pop-up window closes.
 - Press the lift state select key to register the lift state to be used (single top/jib/boom).
 - Each time the lift state select key is pressed, the display changes. If the display agrees with the actual state, press the set key to register. After the completion of the registration, the pop-up window closes.
 - When erecting and stowing jib, select the status of jib set (Jib lift indicator symbol flickers).
- When operating crane on-rubber:
 - Set "P.T.O." switch to "ON".
 - Press the outrigger state select key to register for the on-rubber operation. Each time the outrigger state select key is pressed, the display changes. Select the creep operation, the on-rubber state indicator symbol flickers.
 - Press the lift state select key to register the lift state.

However, pay attention to the following.

(1) For stationary operation.

 - The front capacities are attainable only when the over front position symbol comes on. When the boom is more than 2 degrees from centered over front of chassis, 360° capacities are in effect.
 - When a load is lifted in the front position and then slewed to the side area, make sure the value of the LOAD MOMENT INDICATOR (AML-C) is below the 360° lifting capacity.

(2) For creep operation.

 - The creep capacities are attainable only when boom is in the straight forward position of chassis and the over front position symbol is on. If boom is not in the straight forward position of chassis, never lift load.
- This machine is equipped with an automatic swing stopping device. (For the details, see Operation and Maintenance Manual.) But, operate very carefully because the automatic swing stop does not work in the following cases.
 - During on-rubber operation.
 - When the "P.T.O." switch is set to "OVERRIDE" and the "OVERRIDE" key switch outside the cab is on.
- During crane operation, make sure that the displays on front panel are in accordance with actual operating conditions.
- THE displayed values of LOAD MOMENT INDICATOR (AML-C) are based on freely suspended loads and make no allowance FOR such factors as the effect of wind, sudden stopping of loads, supporting surface conditions, inflation of tire, operating speed, side loads, etc.
For safe operation, it is recommended when extending and lowering boom or swinging, lifting loads shall be appropriately reduced.
- LOAD MOMENT INDICATOR (AML-C) is intended as an aid to the operator. Under no condition should it be relied upon to replace use of capacity charts and operating instruction. Sole reliance upon LOAD MOMENT Indicator (AML-C) aids in place of good operating practice can cause an accident. The operator must exercise caution to assure safety.

GR-1200XL Axle weight distribution chart

	Pounds			Kilograms		
	GVW	1st	2nd	GVW	1st	2nd
Basic machine	122,298	61,233	61,065	55,474	27,775	27,699
Remove: 1. 7.9 ton (7.2 metric ton) hook block	-661	-1,007	346	-300	-457	157
2. 120 ton (110 metric ton) hook block	-2,381	-4,596	2,215	-1,080	-2,085	1,005
3. Top jib	-736	-989	252	-334	-448	114
4. Base jib	-1,889	-3,741	1,852	-857	-1,697	840
5. Auxiliary lifting sheave	-129	-385	256	-59	-175	116
6. Counterweight	-22,046	9,628	-31,674	-10,000	4,367	-14,367
7. Auxiliary winch & wire rope	-2,272	1,022	-3,295	-1,031	464	-1,494



TADANO

TADANO LTD. (International Sales Division)

4-12, Kamezawa 2-chome,
Sumida-ku, Tokyo 130-0014, Japan

Tel: +81-(0)3-3621-7750

Fax: +81-(0)3-3621-7785

<http://www.tadano.com/>

info@tadano.com

Printed in Japan
2017-07-1